

# Assembly Instructions

- 1) Select the drawing with the correct Shelf length and drill holes accordingly.
- 2) Screw the supplied sheet metal screws into studs where possible, otherwise use the metal wall anchors. Weight limits below pertain to stud or woodbacker installation.
- 3) Place the Frame on the screws and tighten until Frame is level.
- 4) Place Shelf over Frame, the lip at the back will lock in place.

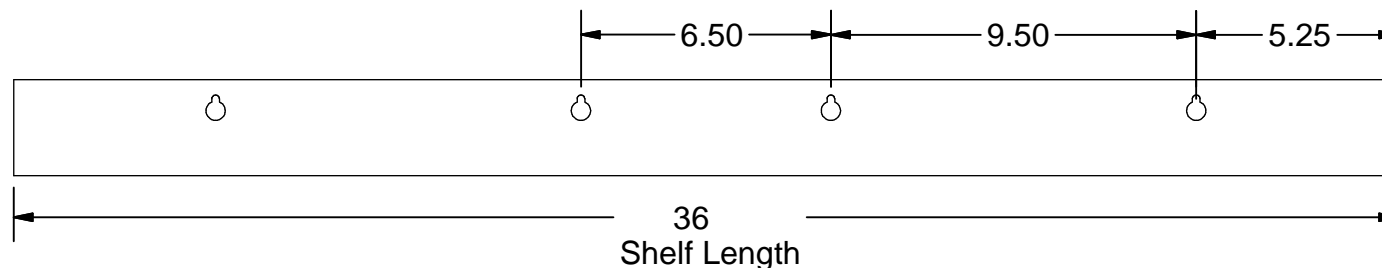
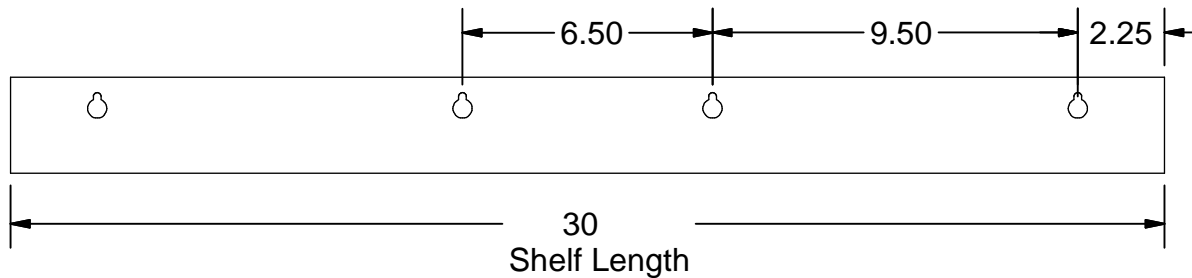
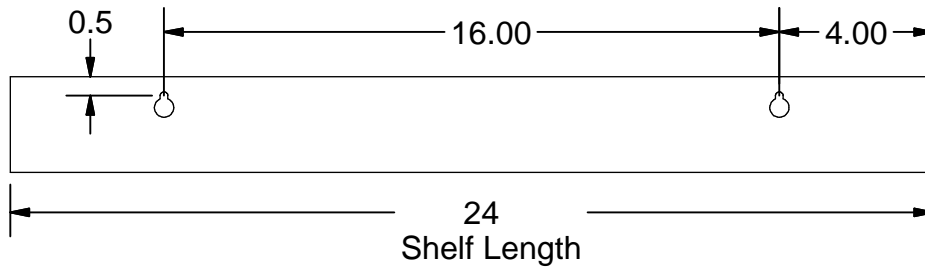
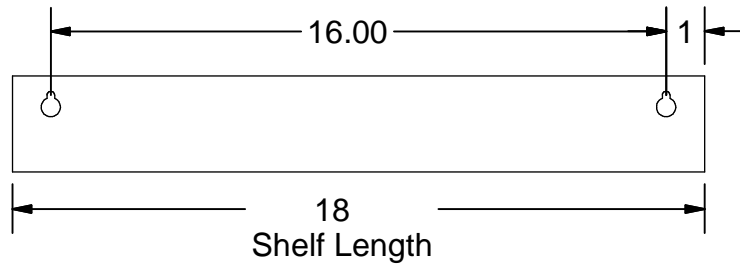

1/8 Drill for Sheet Metal Screws  
3/8 Drill for Wall Anchors

Model	Shipping Wgt Lbs	Rating Wgt Lbs
FS18B	9	60
FS24B	12	60
FS30B	14	60
FS36B	16	60
FS42B	21	120
FS48B	23	120
FS60B	27	120
FS72B	31	120

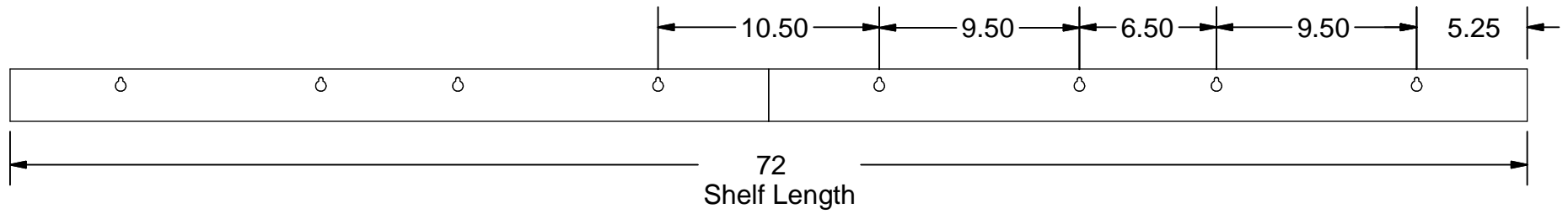
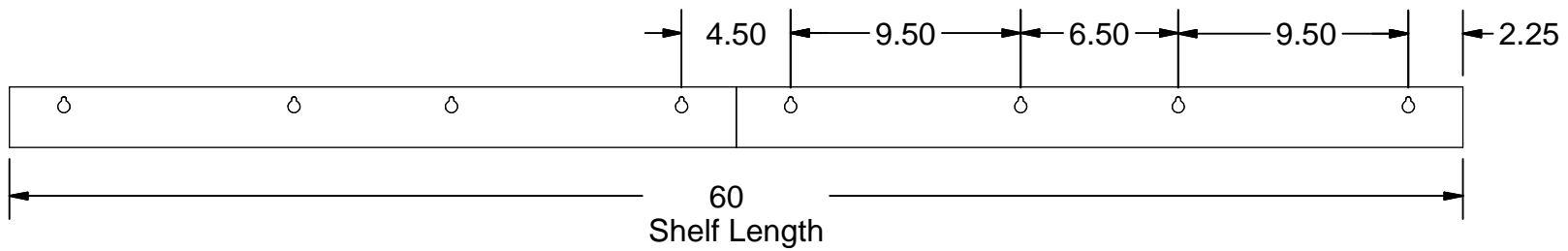
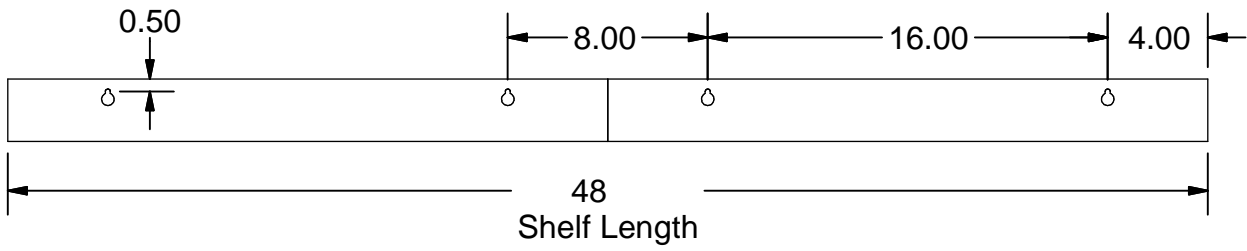
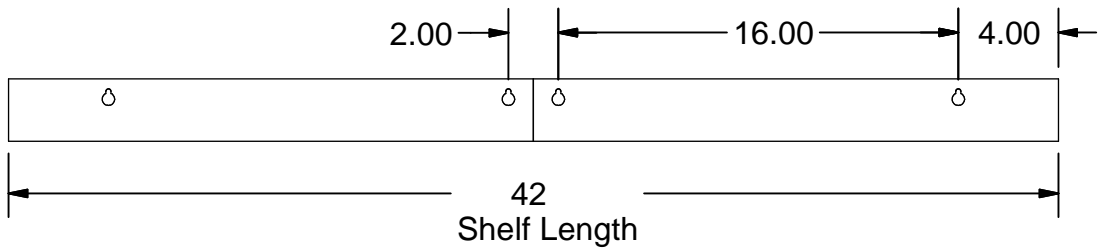

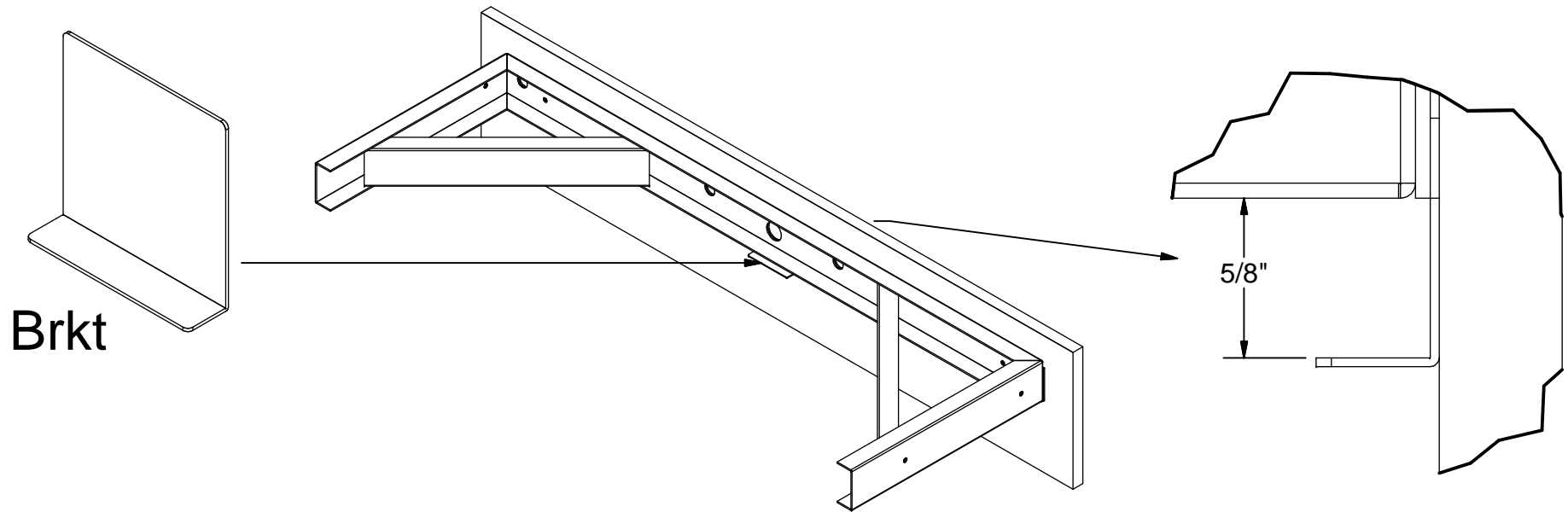

## Instructions to Prevent Sag

On the 60" and 72" shelves you may notice the bottom of the shelf sagging. If you want to prevent this you can add 2 brackets as follows.

- 1) After the frame is mounted, take the Bracket supplied and slide it between the metal frame and wall, approximately centered. Do the same for both frames.
- 2) Slide it up until you have a gap of approximately 5/8". Friction will hold it in place.
- 3) When you place the SS Shelf over the painted frame just make sure the bottom of the shelf is resting on the Bracket.